

VMUG

User/con

The Netherlands

NSX-V vs. NSX-T

Matts Bos



Spreker

Matts Bos

- Infrastructure Consultant @RedLogic



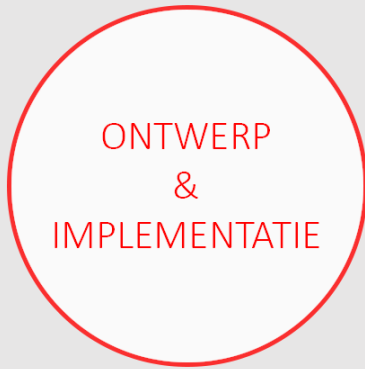

17 vakidioten



Houten

Accomplishments

Partners



Agenda

- Overlay
- Routing
- Loadbalancing
- Hypervisor
- Keuze NSX-V of NSX-T

- Migratie van V naar T



Overlay

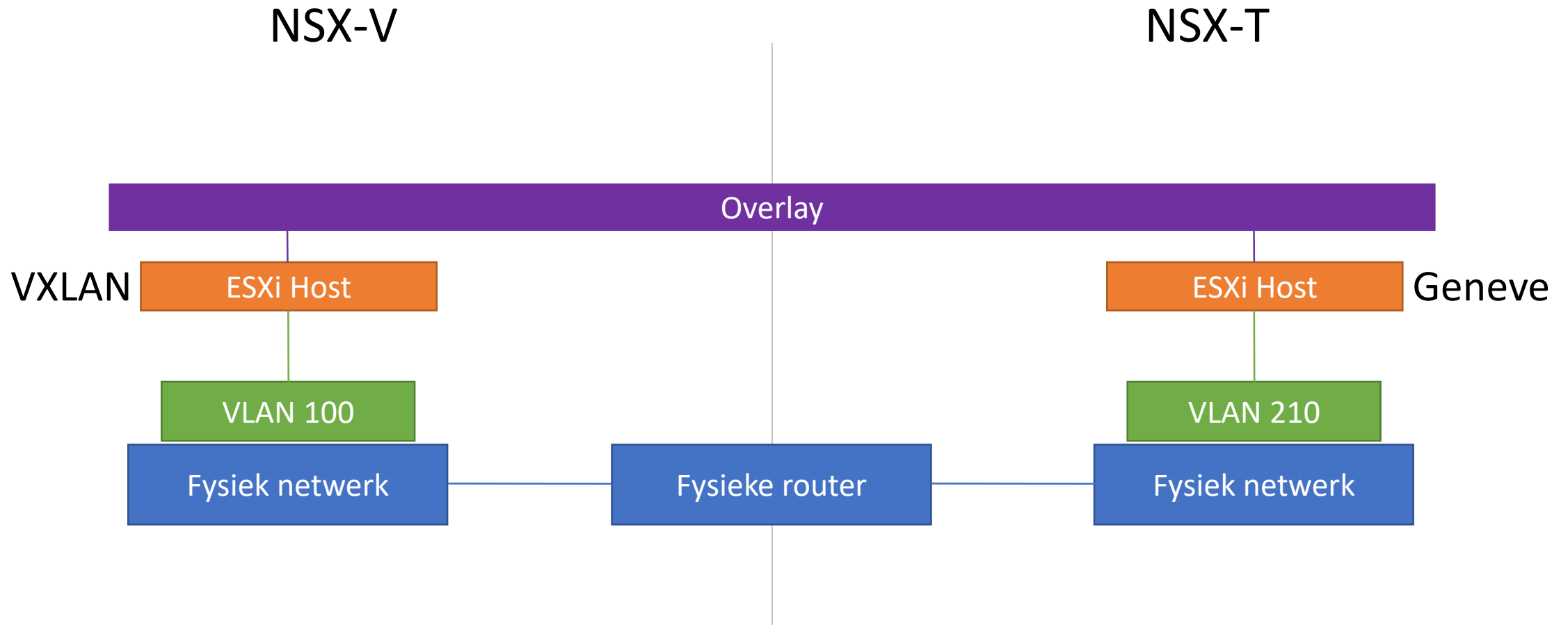

Routing

NSX-V



NSX-T

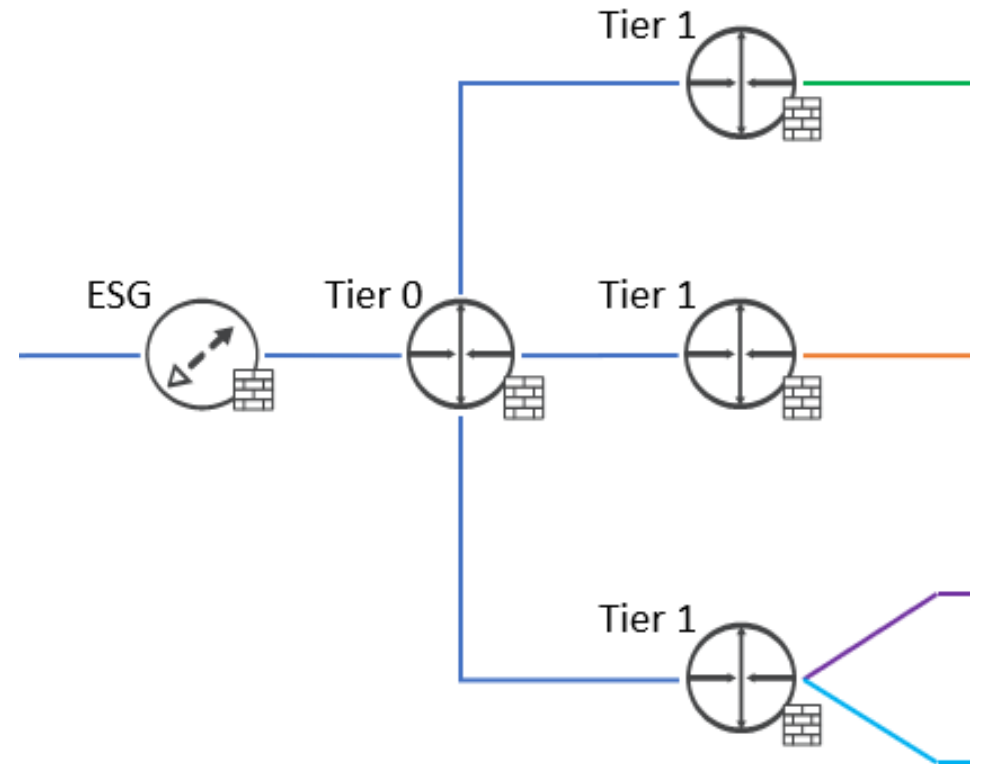

Loadbalancing

NSX-V

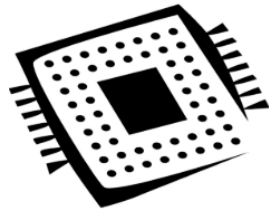

NSX-T

NGINX

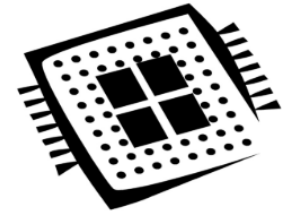

Hypervisor

NSX-V



NSX-T



Vergelijking

Onderdeel	NSX-V	NSX-T
Overlay	VXLAN	GENEVE
Routing	Single-Tier, OSPF/BGP	Multi-Tier, alleen BGP
Loadbalancing	HAProxy	NGINX
Integratie	1:1 met vCenter	Onafhankelijk
Containers	VMware Integrated Containers	Pivotal Container Services (PKS)
Hypervisor	ESXi	ESXi, KVM, Public Cloud
Edge	Virtueel	Virtueel, fysiek



Voorbeeld situatie

- VMware omgeving.
- Private Cloud / On-Premises, ook in toekomst.
- Eis OSPF.
- Bewezen technologie.

NSX-V



Voorbeeld situatie

- VMware omgeving met KVM onderdelen.
- Volledig Cloud Native op Enterprise schaal (PKS).
- Schaalbaarheid m.b.v. Amazon AWS.

NSX-T

Voorbeeld situatie

- Bestaande VMware NSX-V omgeving.
- NSX-V behouden.
- Volledig Cloud Native op Enterprise schaal (PKS).

NSX-V & NSX-T



Migratie van NSX-V naar NSX-T

- Uitgangspunten
- Mogelijkheden



Greenfield migratie

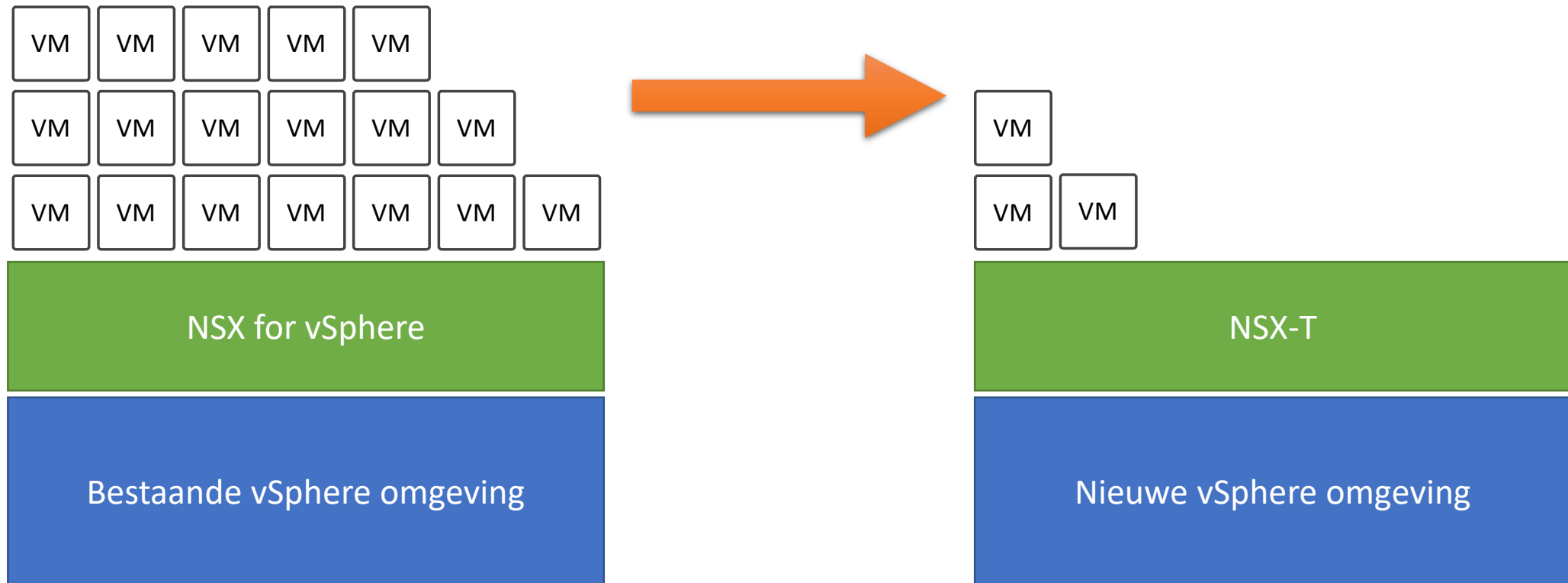

Brownfield migratie: Splitsen

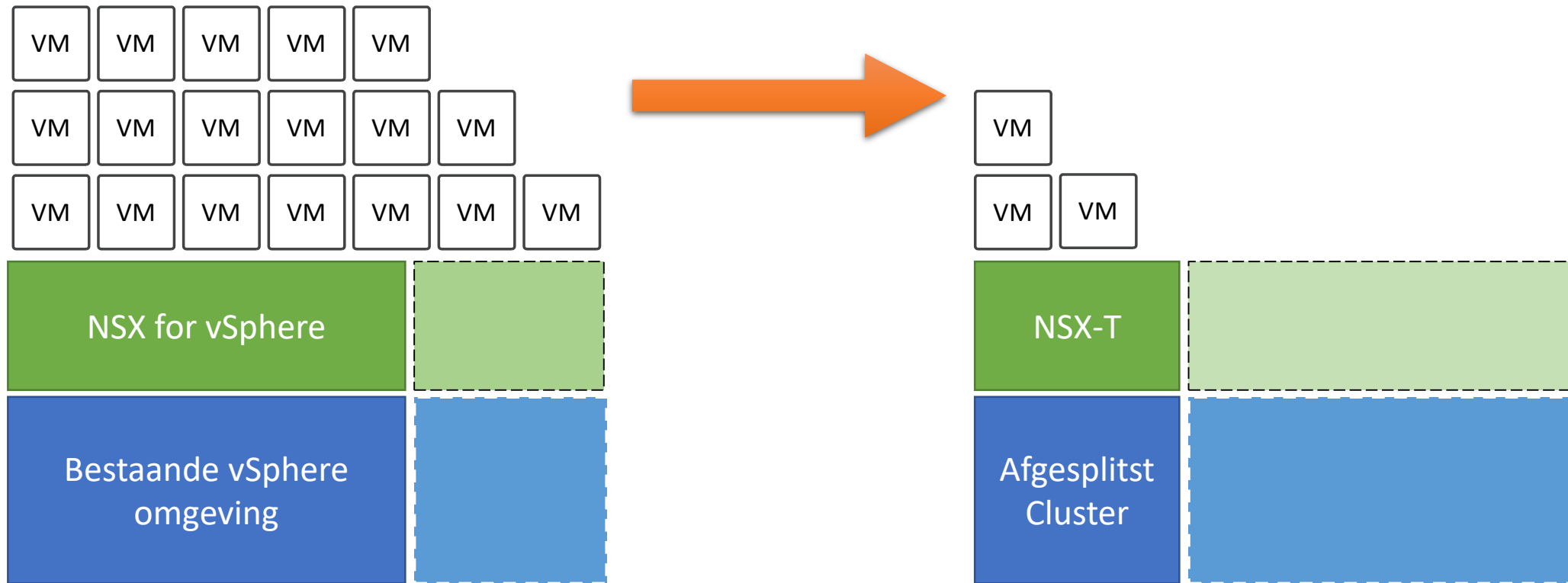

Brownfield migratie: Vervangen

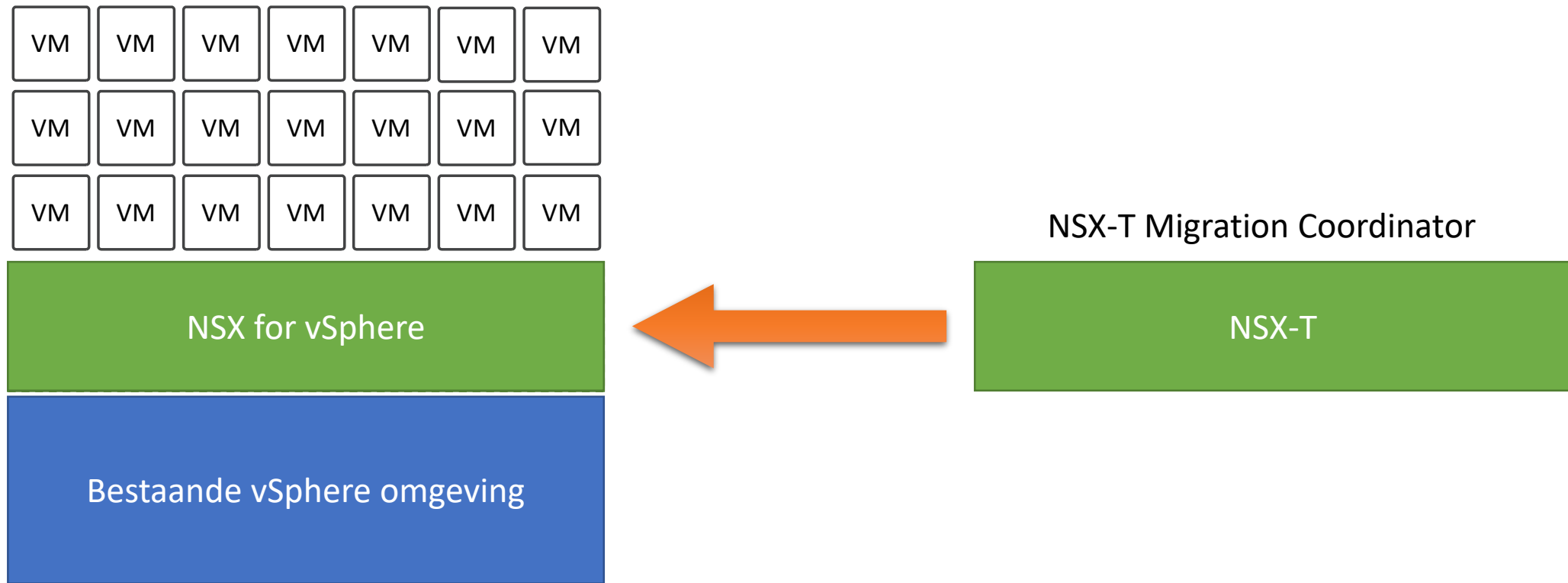



Vragen?

matts.bos@redlogic.nl

VMUG
User/con